

# LUCAS

## TECHNICAL SERVICE

### OVERSEAS TECHNICAL CORRESPONDENCE COURSE

#### Section I LEAD ACID BATTERIES



JOSEPH LUCAS (SALES & SERVICE) LTD · BIRMINGHAM 18



# INTRODUCTION

---

Batteries in one form or another are household commodities to all of us. They are divided into two basic types, known as primary and secondary batteries. The principal difference between them is, that a primary cell is expendable, in other words, once it is discharged its useful life is finished. Whereas a secondary cell can be recharged, and for obvious reasons this is the type that we use in connection with motor vehicles, and will be the one in which we are mainly interested.

Before going into the constructional and technical details of the battery, let us consider the application of this unit from an overall point of view as it affects all branches of the trade, including commercial, technical and service aspects.

These secondary batteries generally follow highly developed basic techniques, but there are a few exceptional ones such as where both the plates and the electrolyte are basically different.

It is quite natural that in the highly commercialised world in which we live the most intensive development has been of those types which use common basic materials and are susceptible to high quantity production methods, in order that they may be produced at a cost in keeping with that of the equipment of which they form part, and this is particularly important in the vehicle field with which we are most intimately concerned.

The part played by the Battery on a vehicle has become an increasingly large and important one, until today vehicles without batteries are practically non-existent and without the battery most vehicles are wholly or at least partly immobilised. Under these conditions the battery is a large revenue earning component in all sections of the vehicle manufacturing and distributive business.

From the manufacturer, through the wholesaler, down to the wayside garage who finally fixes it to someone's vehicle, the battery plays just as important a part in the economic structure of a business as any other component that is sold. In fact, by virtue of its cost a good deal more important part than many others. Therefore, if for no other reason, it is worthy of some close attention and a reasonable degree of understanding.

Fortunately for most of us it is not necessary to be a chemist, or even to know anything much about the chemical technology of a battery to be able to manipulate it successfully in every-day service.

However, some sort of knowledge of the "How and Why" is of course both desirable and useful. Basically, what is miscellaneously known as the Secondary Battery, the Accumulator or just plain "Battery" is a box full of "Chemical Energy", which upon being connected to such components as Lamps, Starters, Ignition Coils and the like, causes an electric current to flow and so energise them to carry out their particular function.

In the following pages we shall go more deeply into the theory, construction and operation of lead-acid batteries in service, for it is felt that only by clearly understanding how a unit is made, will the operator have confidence to give the degree of service which is essential to obtain a long effective life and the purchasers satisfaction.

---

## COPYRIGHT

*All rights reserved. No part of this  
publication may be reproduced  
without permission.*

JOSEPH LUCAS (SALES & SERVICE) LTD., BIRMINGHAM, ENGLAND.

# CONTENTS

---

## PART 1.

### Working Principles of the Lead Acid Battery.

Charged and discharged state — a brief explanation of the chemical change.  
The measurement of electrolyte density or Specific Gravity.  
*The composition of the Modern battery* — grids, plates, separators, cell groups and container.

## PART 2.

### Battery Types and Construction.

Factors which govern the selection of a battery for a given purpose — plate thickness, capacity.  
Engine starting — the effects of temperature on battery output.  
Volt-Ampere curves. Battery Symbols.

## PART 3.

### Putting Batteries into Service.

The significance of the initial charge.  
A brief survey of the chemical changes before the initial charge.  
*Breaking down* of the acid — Temperature correction.  
*Filling* — single and two stage operations.  
*Soaking.*  
*Charging Systems in brief* — The constant current and constant voltage methods.  
*Initial Charging* — Rate and duration of charge.  
*The 'Dry-Charged' Battery* — Why initial charging is unnecessary.

## PART 4.

### Batteries in Service.

*Maintenance* — Corrosion and its effect.  
Old and New type Battery lugs. The replacement of lugs and cables.  
*Testing* — The Hydrometer test ; the Heavy Discharge test.  
*Recharging in Service* — charging methods in detail.  
The constant current and constant potential methods.  
Rapid charging ('The Boost Charger') — the importance of temperature control.  
The effects of low temperature.  
*The Electrolyte Level* — 'Topping-up.'  
Filling devices — 'The Lucas Battery Filler.'  
The 'Correct Level Device.'  
Current Losses — self-discharge, surface discharge, intercell leakage.

## PART 5.

### Batteries in Storage.

*The Results of Ill-Treatment.*  
Storage Conditions — the importance of temperature, Stacking.  
*Dry uncharged batteries in storage.*  
'Charged' batteries in storage — the freshening charge.  
Dry-charged batteries — in storage.  
King of the Road Batteries — in storage.  
*The Results of Ill-treatment* — corroded lugs, acid level neglect ; over-discharging ; over-charging ; buckling — its effects on plates and separators.

QUESTION AND ANSWER PAPERS  
STUDENT'S QUERY PAPER  
AIRMAIL REPLY ENVELOPE

# Working Principles of the Lead-Acid Battery

## THE BATTERY

The Lead Acid Battery is simply a device for storing electrical energy in a chemical form. This energy can be released as electricity when needed.

Electrical energy is converted into chemical energy during the charging of the battery.

During discharge, the energy stored in the chemicals is released as electricity.

Let us assume that our battery is discharged. By this we mean that it is no longer capable of releasing electricity at a usable voltage or pressure. The electro-chemical energy built up in the plates of each cell during the charging process has been exhausted, and the chemicals themselves, instead of being active storsers of electrical energy, have become inactive or inert.



## CELL ON CHARGE

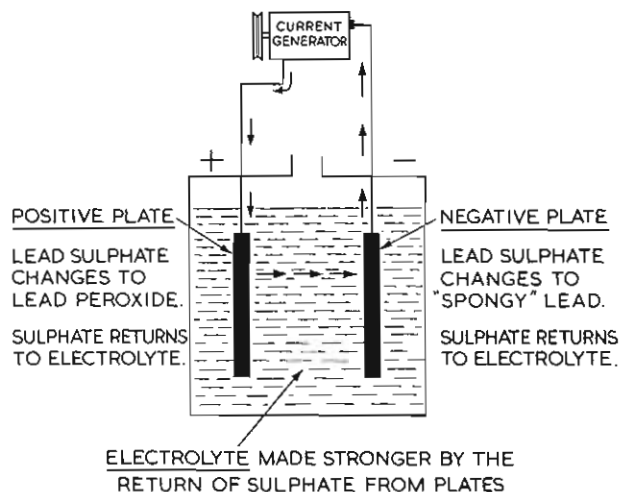

## CELL ON CHARGE

It is the function of the charging current to break down these inactive chemicals on the battery plates, converting them once more into active materials.

Both positive and negative plates in the discharged condition are covered by a film of Lead Sulphate. During charging this is converted, at the positive plate to active Lead Peroxide, at the negative plate to active 'spongy lead.' The chemicals in this form are once more capable of storing energy and delivering electricity. The sulphate from the Lead Sulphate compound we've just broken down, cannot just disappear of course : it combines with the electrolyte surrounding the plates, thus concentrating the dilute sulphuric acid solution.

At the same time, a mixture of gases is given off from the battery. Hydrogen gas first appears in the form of bubbles on the surface of the negative plate ; oxygen gas is attracted in the same form to the positive. The gases not used in the chemical reaction are then liberated from the battery as the plates become fully charged.

## DISCHARGE OF CELL

We can now regain the energy we have just put into the plates by connecting them externally — a bulb is shown here completing the circuit. The electric current thus released flows through this circuit in the opposite direction to that of the charging current, and the active materials of both positive and negative plates gradually return to their inactive state, that is to inert lead sulphate. The sulphate part of this compound comes of course from the sulphuric acid of the electrolyte, thus leaving a weaker solution.

## DISCHARGE OF CELL

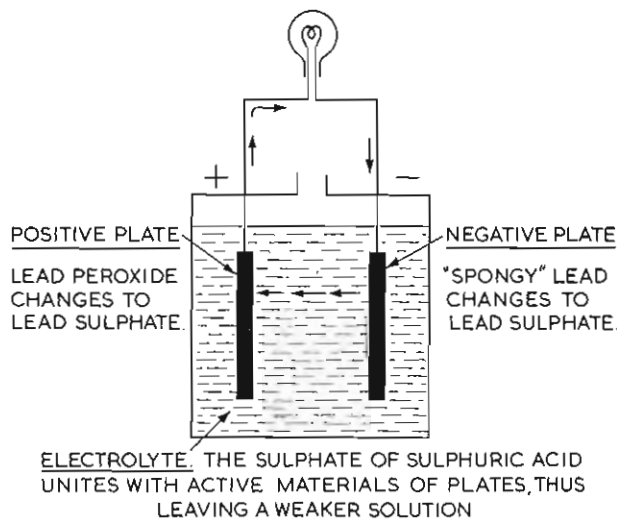

## CHARGED AND DISCHARGED CONDITION.

In this diagram the sulphate group is represented by dots. You can see that in the charged condition the sulphate has disappeared from the plates and is concentrated in the electrolyte: in the discharged state the sulphate group leaves the acid, becoming concentrated in the plates.

The electrolyte, which as you know, is a solution of sulphuric acid, is thus strong when the battery is charged and weak when the battery is discharged. This gradual weakening of the electrolyte is directly proportional to the amount of electricity delivered. If now we could measure the amount of the sulphate group remaining in the electrolyte, we should be able to judge how much electrical energy is left in the cell.

The "Hydrometer" is the instrument which enables us to take this measurement, the measurement of density.

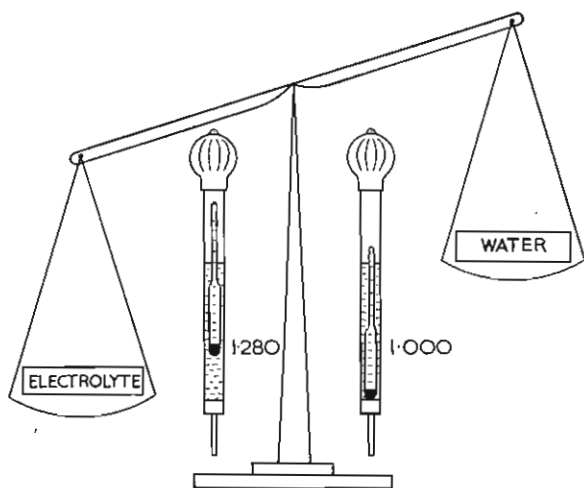
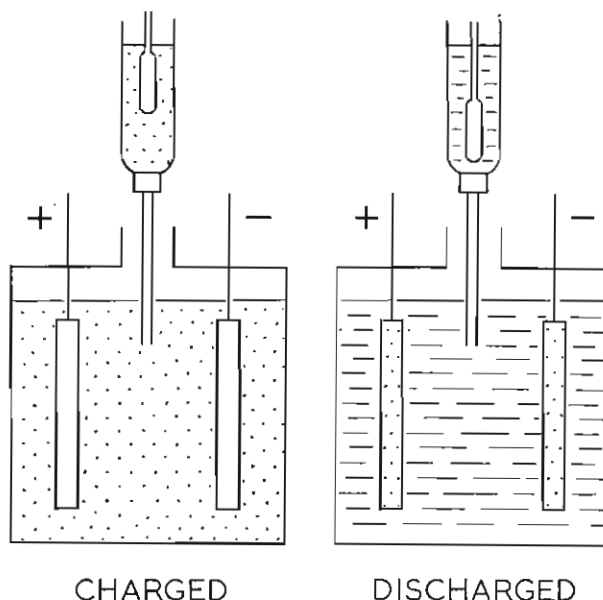

ELECTROLYTE FOR FULLY CHARGED BATTERY  
IS 1.28 TIMES HEAVIER THAN WATER.

## DENSITY

Water is taken as the standard basic unit and given a density of 1. Thus in effect we are weighing the electrolyte acid against water. The denser or heavier the electrolyte, the higher will be the hydrometer float, and consequently the reading. Thus for a fully-charged battery, when the electrolyte is most concentrated, we shall have a hydrometer reading of approximately 1.280 — this is the everyday method of saying that our acid is 1.280 times heavier than water. This density is usually referred to as the SPECIFIC GRAVITY or "S.G." of the acid. And, as the battery cell loses its energy in the form of electricity, so the hydrometer float will sink and the density reading or "S.G." fall. You can see how, in the right of the picture, the float has sunk just about as low as a float can sink.

Thus the hydrometer reflects fairly accurately the state of charge of the cell, always providing that the cell is in a normal condition.

## GRIDS AND PLATES

We have attempted to show you so far how the Lead-Acid Battery stores and delivers electricity and in so doing we have dealt a little with the chemical processes involved.

The basic idea of immersing two dissimilar plates in a liquid capable of conducting an electric current still remains today, but the method of constructing and assembling these plates has progressed.

We start with a lead frame work or grid, strong enough mechanically to withstand vibration; and conductive enough electrically to offer little resistance to the passage of current. These grids are filled with the active materials, and the plates so formed, built into positive and negative groups.

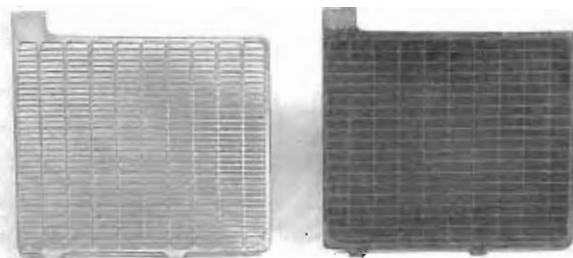

## GROUPS OF PLATES - SEPARATORS

The plates of the positive and negative groups are then interleaved and separators added between the plates, thus forming a complete cell unit.

These separators are an essential part of the battery, as their name implies they separate the negative from the positive plates. An effective separator must : prevent short-circuits between the plates ; offer no resistance to the electro-chemical action and what's more be reasonably immune from the corrosive effect of the acid electrolyte.

All these demands have been met adequately for many years by wood. The thin sheets used are suitably porous and sufficiently resistant to acid of normal battery strength.

For all normal purposes, wood separators give excellent service. An alternative now being widely used is the Porous Rubber Separator as fitted in the latest models of Lucas Car and Motor Cycle Batteries.

These rubber separators have even greater mechanical strength and decrease even further the possibility of internal short circuits.

For batteries, which are at times subjected to severe vibration stresses, sheets of compressed glass fibre are now being used as a further reinforcement of the separation, in addition to the porous rubber.

Ebonite is another material used, particularly for the heavier batteries.

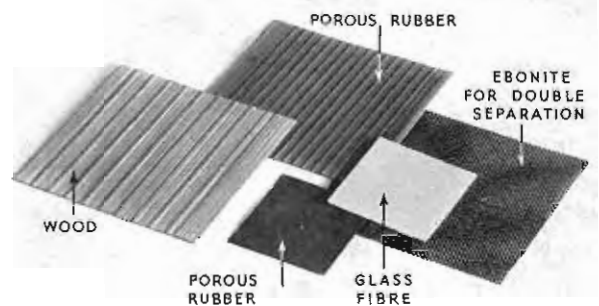
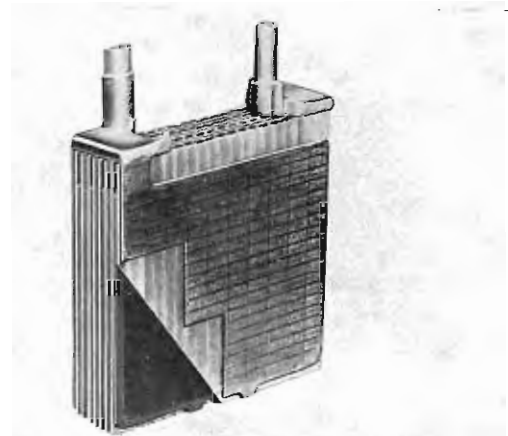

## EXTERNAL FEATURES.

The Internal Construction of vehicle batteries has developed steadily "unseen" but until quite recently external features have not altered greatly until the introduction of the "Linkless" type of construction used on the GT range of batteries which are now so popular. One of the advantages in this simple and workmanlike assembly, is the saving in weight whilst retaining an ample cross section of metal to carry the maximum currents required together with perfect sealing between the cells.

In the case of the larger commercial batteries, used on heavy diesel and petrol engines, heavier intercell connectors and posts are used to offer as little resistance as possible to the extremely high currents. The lead linkages of these batteries are cored with copper.

We have also made modifications to the cell lids of the car type battery. The overall result is an increase both in the life and in the efficiency of the modern battery.

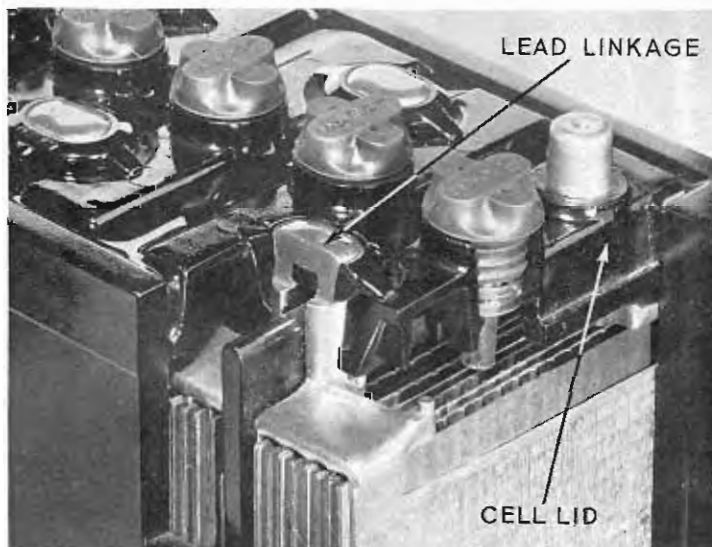

---

## CONTAINERS.

Lucas have developed a battery container with the trade-name "MILAM" (made in Lucas Acid-Proof Material). This signifies the moulded "monobloc" container you see in the illustration. You will notice that the intercell partitions are reinforced (A on illustration), a feature which lessens the chance of current leakage between cells.

There is one further point which must be mentioned in connection with containers. The separators usually rest on ribs at the bottom of the container, thus leaving space for sediment between the bottom of the plates and the container. If this space were *not* present, sediment dislodged from the plates would fall to the bottom of the container and cause internal short circuits.

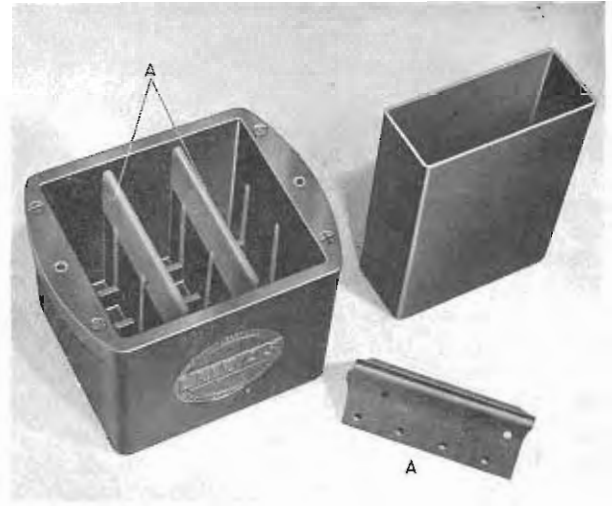

---

## TESTING THE CONTAINERS.

In order to make sure that the "Milam" container is electrically sound, it is first given an electrical Pressure Test at 40,000 to 60,000 volts before being put into service. Any minute flaw in the walls or partitions is indicated by an electrical breakdown in

the form of a flash-over which burns a visible hole or crack at the weak spot.

This is an extremely severe test which ensures that no leakage of current is possible through the container. Any container which breaks down under this test is immediately rejected.



# Battery Types and Construction

## THE LUCAS BATTERY RANGE.

Having briefly outlined the working principles and external features of modern lead acid battery we can now deal with them in more detail, showing you various types, pointing out differences in construction and discussing factors which govern the selection of a battery for a given purpose.

Lucas manufacture a wide range of batteries, varying in size and shape from the small PUW5E Motor Cycle battery to the heavy "C.V." commercial type.

These batteries differ both in design and construction according to the work they will have to perform.

The Containers and Cell linkages vary. So does the material used for the separators and the Plates vary both in size, shape and thickness.

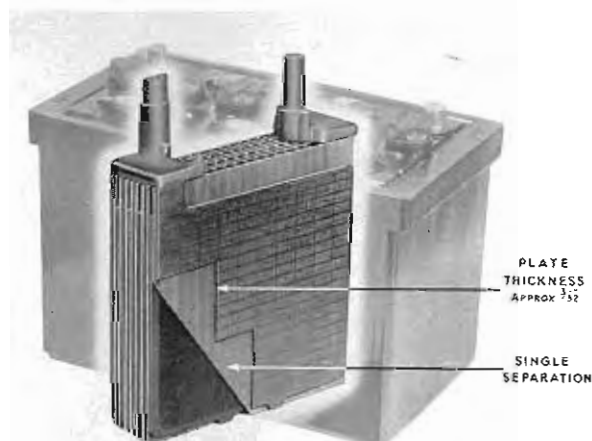

THE "T" TYPE PLATE

## THE "T" TYPE PLATE.

Two of the main factors which concern us when selecting a battery for a particular purpose are :

- (a) The thickness and number of plates per cell.
- (b) The capacity.

We will first deal with plate thickness, upon which the durability of the battery depends, by showing a picture of our "T" type plate. This is approximately  $\frac{3}{32}$ " thick and is normally standardised for use in batteries suitable for light or medium-weight petrol vehicles. You will notice that single separators are used. By that, we mean that adjacent positive and negative plates are separated by a single layer of separating material.

## THE "X" TYPE PLATE.

For exceptionally heavy work on petrol vehicles where a longer life is required from the battery, thicker and therefore stronger plates are used. The illustration shows the "X" type plate, which is  $\frac{1}{8}$ " thick i.e.  $\frac{1}{32}$ " of an inch thicker than the "T" type plate shown above.

You will see that double separators are used between these plates. An additional feature not yet mentioned is the "splash seal" or "splash plate"—which, as the name implies, prevents splashing of the electrolyte from the cell. This is an additional feature of these heavy duty Lucas batteries.

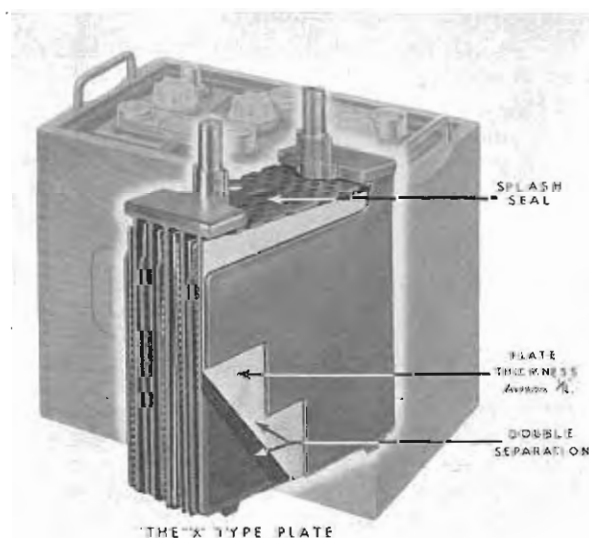

THE "X" TYPE PLATE



### THE "CX" PLATE.

To obtain even longer life and still greater robustness, it is necessary to use still thicker plates. The ones you see in this photograph are  $\frac{5}{32}$ " thick, and known as the "CX" plates.

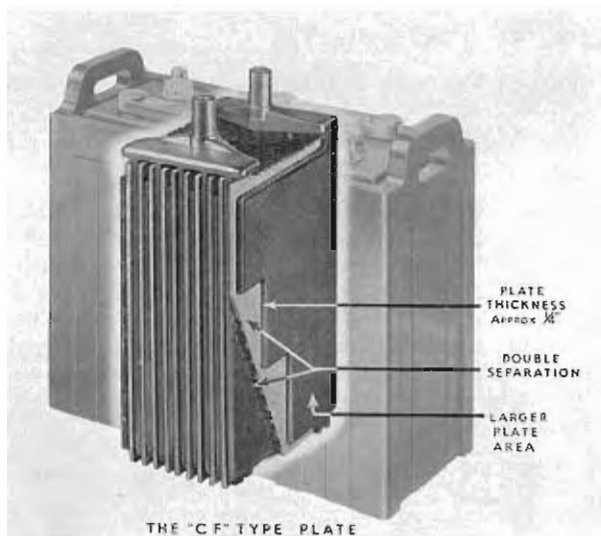
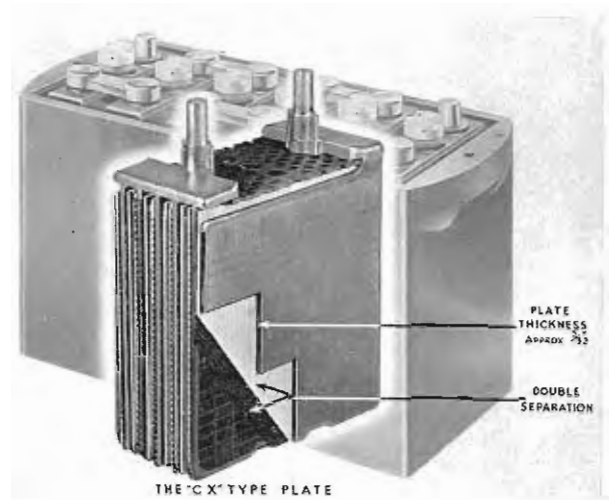

### THE "CF" TYPE PLATE.

We manufacture a further type of plate, the "CF" which is  $\frac{1}{4}$ " thick. This is produced specially for passenger-carrying vehicles.

You will have gathered from the last four pictures that the idea behind all this is simple enough : the thicker the plate, the longer the life. In much the same way we get greater mileage from a heavy-duty tyre.

Batteries with large numbers of the thinner type of plates are capable of providing very heavy current discharges for short periods, but where continuous heavy discharges are required the Thicker Plate batteries are more suitable.

### COMPARISON OF CAPACITY.

The second factor which governs battery selection is capacity.

The capacity of a battery is roughly proportional to the area and thickness of the plates. It is the usual practice to get the largest surface area possible, that is the maximum capacity, by using the greatest number of thin plates per cell. This also allows easy access for the acid to the active material of the plates.

From this you can see that the capacity of the battery is also influenced by the amount of acid in each cell. It also follows that the capacity may often be increased by a more plentiful allowance of acid — that is to say, by the use of wider separation and larger containers. Thus, if some of the active material is uncovered, as when the electrolyte level falls, the extent to which chemical action takes place is obviously reduced and hence the capacity lessened. By this we mean that the ability of the battery to deliver an electric current over a given period of time is reduced.

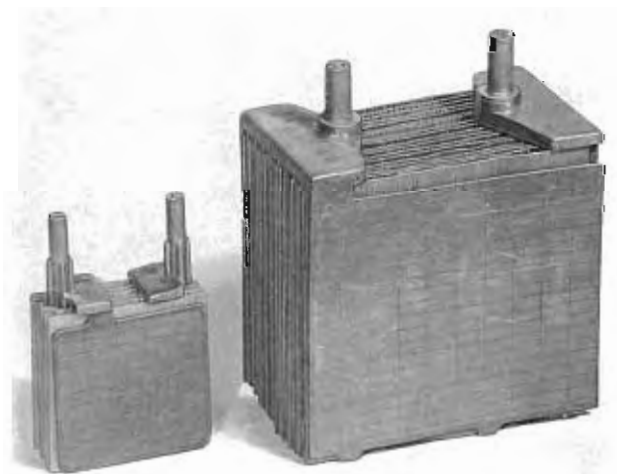

## DEFINITION OF CAPACITY.

Defining this phrase : ' the ability to deliver an electric current over a given period of time ' a little more closely, we can say that here 'current' is expressed in amperes and 'time' in hours. This gives us then the measurement of capacity in 'Ampere-Hours.' A battery can therefore be stated to have a certain ampere-hour capacity if it is capable of delivering a given number of amperes over a stated number of hours.

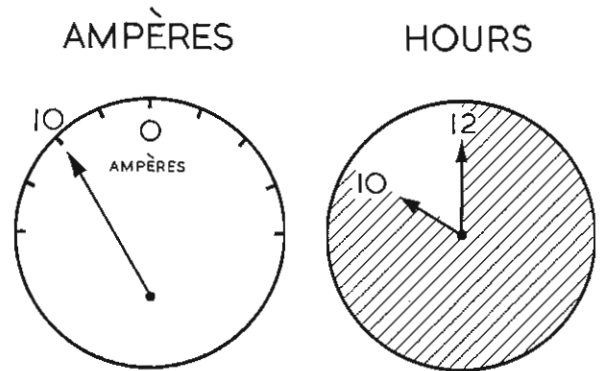

10 AMP DISCHARGE FOR 10 HOURS = 100 A/H. CAPACITY

## THE 10 HOUR RATING.

For the purpose of classifying batteries according to their capacity, the time in hours must be stated. A certain amount of agreement has been reached among battery manufacturers, this time being generally fixed at either 10 or 20 hours. We therefore obtain the expression 'The 10 or 20 hour rating.' In England, the most generally accepted principle is that the declared ampere-hour capacity of a car or commercial vehicle battery is : 'the total number of ampere hours obtainable in a *uniform* continuous discharge lasting 10 hours, starting from a fully charged condition and stopping at the discharged condition of 1.8 volts per cell.'

Thus the following method is normally adopted for testing the capacity of a battery which is suspect.

The battery is first fully charged. Then it is discharged at 1/10 of the rated capacity (10 hour rate)

# The "10 HOUR" Rating

for 10 hours. At the end of this period the cell voltage should not have dropped below 1.8 volts.

If the voltage is below 1.8 volts in less than the 10 hours, the battery is not giving its stated capacity. If on the other hand the voltage remains at this or a slightly higher figure we can be sure that the battery is up to or above specification.

### EXAMPLE 1. (CAPACITY).

A BATTERY IS STATED TO HAVE A CAPACITY OF 100 A.H. AT THE 10 HOUR RATE. AS SUCH, IT IS CAPABLE OF DELIVERING 10 AMPS. FOR 10 HRS. (=100) BEFORE THE TERMINAL VOLTAGE PER CELL DROPS BELOW 1.8v.

### EXAMPLE 2. (CAPACITY).

THE SAME BATTERY COULD HAVE A CAPACITY RATING OF 114 A.H. AT THE 20 HOUR RATE. i.e. IT COULD BE DISCHARGED 5.7 AMPS. FOR 20 HOURS BEFORE ITS TERMINAL VOLTAGE DROPPED TO 1.8 VOLTS PER CELL.

$$5.7 \times 20 = 114 \text{ A.H.}$$

### CAPACITY.

Example one shows you quite simply how the Amp./hr. capacity of a battery is determined.

This limiting of the minimum voltage to 1.8 volts is extremely important. From this you will realise that 'capacity' is understood to express the USEFUL output of a battery.

The second example shows just why discharge times must be standardised and quoted when stating capacity.

Thus you will find batteries catalogued as for example :

CX13 — 116 A/H at the 10 hour rate  
and 133 A/H " " 20 " "

The 10 hour rating is however the more severe test for the battery and is the one we use in the Lucas Organisation.

## HOW ACID STRENGTH AFFECTS CAPACITY.

We have told you that capacity is dependent on plate area and also on the volume of acid in each cell.

In addition, it has already been shown that the performance of a lead-acid battery depends as much on the acid-electrolyte as on the plates themselves, bearing in mind that the electrical output can only be maintained so long as the normal chemical reactions continue between the acid and the active materials.

It is therefore not surprising that the strength of the acid used for filling each cell also affects the output. The strength of the acid not only influences the output available, but also helps to determine

## INFLUENCE OF ACID STRENGTH ON CAPACITY

what the cell voltage shall be. Within certain specific limits, both capacity and cell voltage are affected by the strength of acid.

We shall deal with the normally specified acid strengths in Part 3 of this section of the course.

## THE EFFECT OF TEMPERATURE ON BATTERY OUTPUT.

Besides plate area and the volume and strength of the acid, one further factor influences the capacity and hence the output of a battery : that is, its temperature. Broadly stated :

the lower the temperature, the lower the output,  
the higher the temperature, the higher the output.

There are however limits to this rule in practice.

Let us take an actual example from discharge tests carried out on a given battery in a fully charged condition :

Temp.	Discharge current	Volts
80°F.	217 amps.	at 10V.
40°F.	178 amps.	at 10V.
10°F.	153 amps.	at 10V.

The main reason why temperature affects the output of the battery, stated simply, is that the chemical reactions are accelerated by increasing the temperature of the electrolyte. The acid is then more able to search into the pores of the plates, that is, make more immediate and intimate contact with the active materials.

In cold weather the density of acid, its viscosity if you like, increases and slows down diffusion, thus slowing down the rate of chemical action, and hence effecting the output.

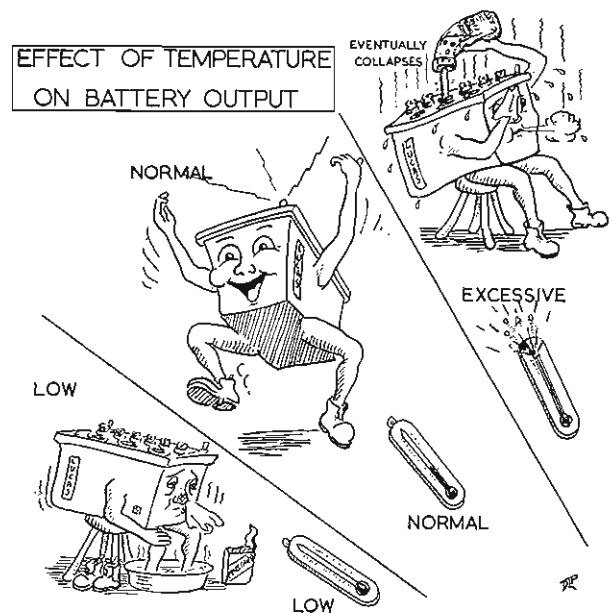

Apart from this mainly chemical reason, at higher temperatures porous separators often transmit the acid more freely than at lower temperatures. This effectively decreases the internal resistance of the cell, still further improving the reaction.

Additionally, at low temperatures, the negative plate tends to lose some of its sponginess, thus restricting the action of the cell, limiting its output.

We shall now discuss further how temperature affects our battery, particularly in relation to engine starting.

## STARTING CURRENTS.

In general terms, to obtain easy starting from cold minimum engine cranking speeds of about 90—110 r.p.m. are required.

To turn the engine over at this speed we must have a battery capable of delivering the required current to the starter motors down to temperatures of 20—25°F. What is more this current must be delivered at a minimum pressure of 8.5 volts on the 12 volt system or 16 volts on the 24 volt system.

The Tables shown for both systems give a fair idea of the currents required for average engines of between 2 and 4 Litres which generally use the 12 volt system, and which will require from 200—300 amperes and for engines of 4 to 8 Litres which generally use the 24 volt system.

For the larger engines, the current would rise very considerably if we did not increase the operating voltage of the vehicle system to 24 volts.

At these voltages the current drawn from the battery is generally limited to between 300 and 450 amperes.

## 12 Volt System

2 to 3 litre Engines  
250 to 300 amps. at 8.5 volts.

3 to 4 litre Engines  
300 to 325 amps. at 8.5 volts.

## 24 Volt System

4 to 5 litre Engines  
300 to 350 amps. at 16 volts.

6 to 8 litre Engines  
350 to 400 amps. at 16 volts.

8 to 10 litre Engines  
400 to 450 amps. at 16 volts.

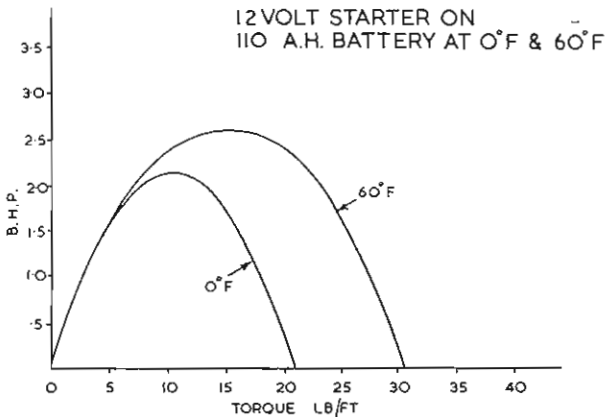

## B.H.P. AND TORQUE.

To develop full power from the starter motor down to temperature as low as 20°F. you will appreciate that the battery size and capacity must be carefully chosen. Using, for example, a 12 volt 110 A.H. battery we can obtain with a given starter motor a turning effort or torque of 30 lbs.ft. at normal temperature (approximately 60°F.).

If now the same battery were used at 0°F., the current available would be seriously reduced and the maximum torque no more than 20 lbs., ft. That is, our battery is approximately one third less effective at the lower temperature.

## COLD WEATHER AND THE BATTERY.

Let us consider the practical application of all this. It is a fact that in mild summer weather we can obtain the required cranking speed of 100 r.p.m. by using, say, an ordinary car-type battery for a heavy commercial vehicle. But in cold weather, this battery, with its thin plates and general light construction, would rapidly fail. Added to the effect of low temperature on the battery, there would be increased oil resistance, combustion difficulties and so on, until finally the work would be outside the scope of the car-type battery. A heavier, larger capacity battery would have to be used.

In our illustration, the top battery would be capable of cranking the engine at 60°F.; but the same battery would not be big enough for the job at the low temperature of 20°F. For this application, a much larger battery would have to be used.

## BATTERY CAPACITY REQUIRED

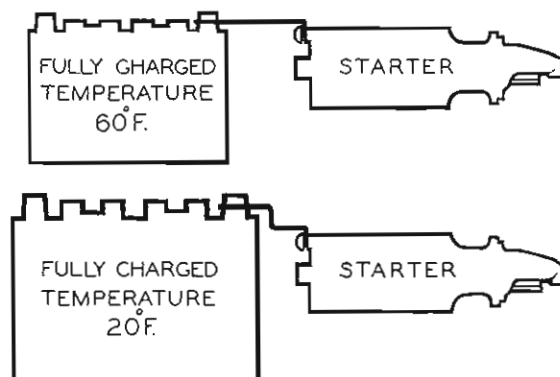

## CONDITIONS FOR BATTERY SELECTION.

Do not forget that in cold weather, with early lighting-up time, the battery will seldom be fully-charged in the mornings.

It has therefore become the usual practice for vehicle manufacturers to select a battery capable of providing the required minimum cranking speed when in a 70% charged condition at approximately 20°F. You will note that this temperature is considerably lower than the freezing point of water.

## BATTERY CAPACITY REQUIRED

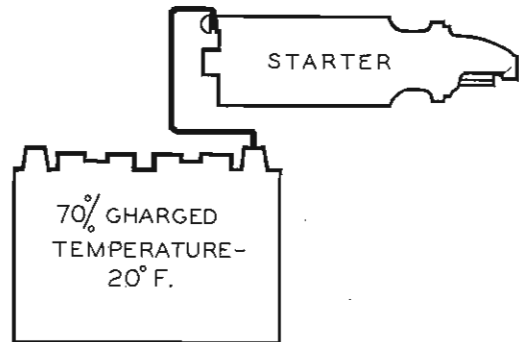

## VOLT/AMP CURVES.

As a convenient and easy guide to the selection of a battery for any specified application Volt-Ampere Curves are prepared which show graphically the performance of a battery over any desired temperature range at any particular state of charge.

As will be seen from the illustration the battery voltage is plotted on the vertical ordinate and the amperes output horizontally. The "Solid" line curve shows the discharge performance of a CX 13 plate battery, 70% fully charged, and the "Broken" line curve the performance for a similar 7 plate battery. In both examples the discharge readings are plotted at temperatures of 65 and 20°F.

Now say for example that we require a starting current of 275 amperes at 8.5 volts at a temperature of 20°F.

By following the horizontal line from 8.5 volts to the point of intersection with the curve for the 13 plate battery, it will be seen that well over 275 amperes are obtainable at the minimum temperature of 20°F., whereas the comparable current from the 7 plate battery would only be about 150 amperes, as shown

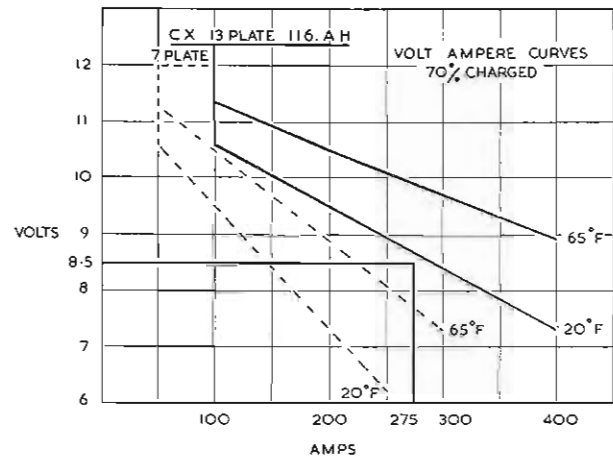

at the intersection with the broken line, and whilst it might start the engine in warm weather, it would be quite unsatisfactory under colder conditions.

The specification of Amperes, Voltage and Temperature is generally decided at the design stage of the engine or vehicle and governs the type and size of battery fitted as standard equipment.

On medium and heavy goods vehicles, cold starter currents govern the capacity of batteries used.

## COLD STARTING CURRENT.

Now we have seen how the capacity of a battery for a vehicle is determined by the current required for cold starting. This applies generally to all cars and commercial vehicles. In addition the lighting load when the vehicle is parked should be taken into consideration as this does, of course constitute a drain on the battery, particularly if sustained over a number of hours.

## PASSENGER SERVICE VEHICLES.

Most rules however, have their exception, and in this case the exception is the "public service" or "passenger carrying" vehicle. Here the lighting-load during normal running is very heavy, and experience has shown us that the capacity for a battery under such service conditions can best be calculated by multiplying the "lighting-load" by 6. That is, for a total lighting load of 25 amps., the *minimum* satisfactory capacity would be 150 Amp./hours at the 10 hour rate. Generally this capacity would be more than sufficient to meet the starter requirements.



## SUMMARY OF FACTORS GOVERNING BATTERY SELECTION

Finally we can summarise these factors with which we are concerned when selecting a battery for a particular vehicle.

*The thickness of the plates*—upon which the durability of our battery depends. And in this connection we must not forget the separators.

*The Capacity*—which determines the battery output. Remember here how the output depends on the size and number of plates, and on the strength and volume of the acid electrolyte.

*The Cold Starting current*—here, temperature, the type of starter and engine etc., must be taken into consideration.

*Lamp Load*—you will remember that this applied only to Passenger Service vehicles.

All the above factors have been taken into account by our battery technicians, and charts have been prepared which enables us, in practice, to see at a glance which battery is suitable for a particular purpose.

We also issue publications which show the interchangeability of Lucas batteries with other makes, including those fitted to American vehicles.

## PASSENGER SERVICE VEHICLES

Battery Capacity determined by  
LAMP LOAD

## SUMMARY

THICKNESS OF PLATES  
TYPE OF SEPARATION USED  
CAPACITY  
COLD STARTING CURRENT  
LAMP LOAD  
(PASSENGER SERVICE VEHICLES)

We can further summarise this part by giving you a list of battery symbols. By referring to these symbols, a Lucas agent knows immediately the type of battery he is dealing with.

If we take for example the 'GTW9A' battery you can see what type of container and cell connectors are used; the type and size of plates; that it has wood separators, 9 plates per cell and a nominal voltage of 12 volts.

Symbols are used to cover the whole of Lucas battery productions. However, we have given here only those symbols commonly encountered.

### LUCAS BATTERY SYMBOLS

B.	SQUARE-ENDED CASE WITH COMPLETELY SUNKEN CELL CONNECTORS.
F.	" " " WITH PROVISION FOR HOLDING RODS.
G.	" " " WITH SEMI-LINKLESS CELL CONNECTORS.
M.	MONOBLOC CONTAINER.
P.	PLATFORM MOUNTED. (MOTORCYCLE BATTERY.)
R.	ANCHORED IN RUBBER. ( " " )
CX.	TYPE OF PLATE.
CF.	" " "
T.	" " "
X.	" " "
U.	" " " (FOR MOTORCYCLE USE).
L.	" " " (LOW TYPE PLATE OR LIGHTWEIGHT BATTERY)
W.	WOOD SEPARATORS.
7, 9,	11, 13 etc. NUMBER OF PLATES PER CELL.
A.	12 v.
E.	TERMINAL LAYOUT.
	6 v.

EXAMPLE GTW9A.

### LUCAS BATTERY SYMBOLS

SPECIAL BATTERIES	
/F.	SPECIAL CONTAINER.
/L.	SPECIAL ASSEMBLY.
/T.	HANDLES MOULDED INTEGRAL WITH CONTAINER.
/6, /8.	SPECIAL ASSEMBLY.
FR.	FERGUSON.
Z.	DRY CHARGED.
SAY.	SPECIAL SOUTH AFRICAN.
SALY.	SUPERSEDED BY SAF. S. AFRICAN.
SFLY.	} AMERICAN REPLACEMENTS.
SVFR.	
SVWT.	
SAFW.	
SVWM.	

## Putting Batteries into Service

We shall assume, in this part of the course, that the batteries to be put into service have arrived in what we might term 'factory condition.' By this, we do not mean that they have luckily survived the rigours of transit, but that chemically they are conditioned to

receive their initial charge.

To give you an idea of the significance of this charge, it is first essential to survey briefly the manufacturing processes and the resultant chemical changes the battery has undergone before it reaches you.

### PLATE FORMATION.

We have limited the chemistry to an absolute minimum as you can see, giving only the essentials ; and you are already familiar with some of the terms from the first part of the course — the Active materials. Lead peroxide and "spongy lead" for instance. But we must start at the beginning.

Pure lead is converted into Lead oxide by combining with the oxygen of the air. This lead oxide is the essential ingredient of both positive and negative plates. During the "formation process", in which the plates are immersed in dilute sulphuric acid and an electric current passed, the chemicals on the plates are converted into their active form i.e., Lead Peroxide at the positive plate and 'spongy Lead' at the negative. At this the plates are fully charged. Normal plates are finished at this stage, dried and ready for building batteries.

Unfortunately, however, during the normal drying process, although the positive plate is unaffected, the "spongy lead" of the negative plate inevitably combines with the oxygen of the air and reverts to Lead Oxide, thus losing its charge.

Thus a battery fitted with these plates leaves the factory termed "DRY UN-CHARGED." Hence the necessity for the further charging process, known as "first" or "initial" charging.

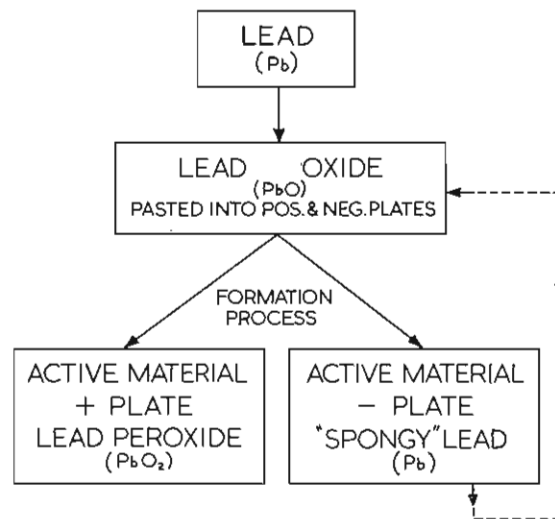

### PLATE FORMATION

The illustration shows the progressive change which takes place during formation and how after completion the negative plates return to the lead oxide form upon being exposed to the atmosphere.

### BREAKING DOWN THE ACID.

We can now set about this initial charging with a little knowledge at our finger-tips, hoping that it won't prove a dangerous thing.

If you remember that, when preparing acid for filling the battery, you dilute by adding ACID TO WATER, there will be no danger.

Start with a large earthenware, glass or lead-lined vessel ; partially fill with distilled water and pour the concentrated acid slowly into the distilled water. If, by the way, you are impulsive enough to pour quickly, we can dissuade you by saying that hot, spitting acid is not considered beneficial either to the skin or to the clothing.



ALWAYS ADD ACID TO WATER SLOWLY

### MIXING PROPORTIONS.

The S.G. of the concentrated sulphuric acid for commercial purposes is 1.835. The gravity of the "filling acid" varies between 1.350 to 1.215, and to get the correct electrolyte strength, the proportion of acid to water should be as shown in the figure.

TO OBTAIN SPECIFIC GRAVITY (WHEN COOLED TO 60°F.)	ADD ONE PART BY VOLUME OF ACID (1.835 S.G.) TO DISTILLED WATER BY VOLUME AS BELOW
1.215	3.9 PARTS
1.245	3.3 "
1.260	3.0 "
1.275	2.8 "
1.290	2.6 "
1.320	2.3 "
1.350	1.8 "

### TEMPERATURE CORRECTION.

When using a hydrometer to test the electrolyte strength during or after mixing, it must be borne in mind that all readings are to be corrected to 60°F., as, due to expansion, the gravity varies with temperature. To correct the hydrometer reading to "true" reading, add .004 for every 10° over 60°F. and subtract .004 for every 10° under 60°F. If, for instance, we obtained a gravity reading of 1.300 at the mean temperature of 60°F., no correction would be necessary. However, with a temperature of 100°F., the "true" gravity reading would be 1.316 when the hydrometer indicates 1.300. Likewise at 30°F. the "true" reading would be 1.288 when the hydrometer reads 1.300.

The same temperature correction must also be observed during charging, when the battery temperature rises.

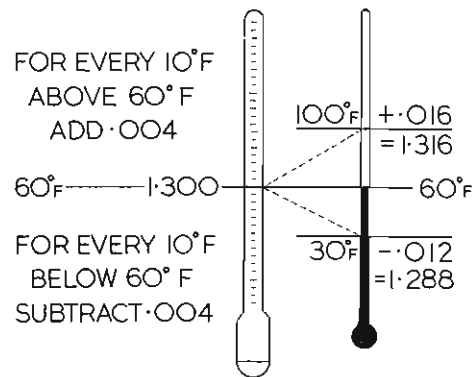

EFFECT OF TEMPERATURE  
ON HYDROMETER READINGS



### FILLING THE BATTERY.

The specific gravity of the filling-acid varies with the type of battery, being mainly dependent on the separator used.

In the case of WET WOOD separators for instance, the electrolyte would be diluted by the moisture in the separators. In batteries where our new porous rubber separators are used, the electrolyte strength is again different from that used in batteries with wood separators.

In this respect, therefore, the instructions printed on labels attached to all Lucas batteries should be closely followed, the final electrical output of the battery being dependent on the electrolyte strength used.

We will also point out that acid that is much too strong can quite easily char the wood of the separators, apart from shortening the life of the active materials in the plates.



### SINGLE AND TWO STAGE FILLING.

Another factor too must be considered : when batteries with wet separators are filled, a great amount of heat is generated from the mixing of the acid and the water. Further heat too is generated as the result of chemical action in the negative plate. This heat is likely to cause cracks in the moulded battery container. Thus batteries with wet separators and moulded containers must be filled in two stages. The battery should at first be half-filled and then an interval of six hours for cooling allowed between stages. A further two hours should be allowed after the second stage.

This two-stage filling also applies to DRY-UNCHARGED batteries with porous rubber separators and moulded containers. Heat will still be generated, remember, from the negatives.

One-stage filling is however permissible for all motor cycle batteries.

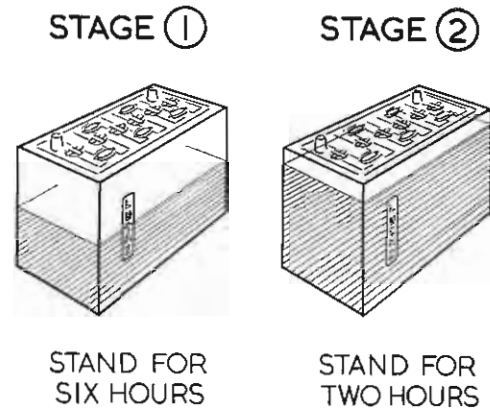

### TWO STAGE FILLING

## Filling and Soaking Wood Crated Batteries

Specific gravity of filling acid 1.320, at 60°F. Fill to top of separators in **ONE** operation. Stand for **TWELVE** hours before commencing first charge.

### FILLING AND SOAKING FOR WOOD CRATED BATTERIES.

The cells of these batteries consist of separate ebonite jars and may be filled to the level of the separators in ONE operation.

These batteries must then be allowed to stand for TWELVE hours before commencing the initial charge.

### CHARGING SYSTEMS.

There are two charging systems in use, the constant current and the constant voltage method.

For *initial charging* we strongly recommend that only the *constant current* method be used. By this we mean that the batteries are connected in series and the current flowing through them kept constant.

If there is no alternative the "constant voltage" method may be used, but resistances and ammeters must be inserted in the circuit, so that the current flowing through *each* battery can be continuously supervised.

On no account should "Rapid Chargers" or "Boosters" be used for initial charging.

### CHARGING METHODS

Constant current or constant  
Voltage?

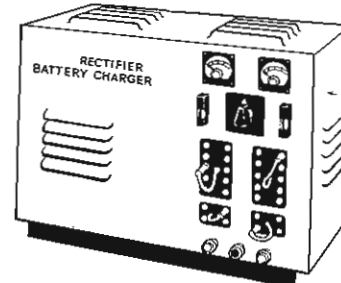

For first charging work use  
**CONSTANT CURRENT  
CHARGING ONLY**

### CONSTANT CURRENT CHARGING.

A maximum voltage of 110 volts has been found the most satisfactory. *We must stress here that only a DIRECT CURRENT Source can be used for battery charging.*

Whenever possible, batteries of the same capacity should be initially charged together and, for efficient work, no more than five 12 volt batteries, or ten 6 volt batteries should be in one bank. The number of banks depends of course on the current output available from the generator or supply used. Variable resistances can be employed for adjusting the current flow in each bank. The actual method of connecting the batteries in series can be seen from the illustration opposite.

Remember that a loose connection makes for an inefficient charging system and that any sparking is likely to fire the explosive gases released during charging. If a battery has to be taken off charge do *not* forget to switch off the charging current first.

Further details of charging methods will be dealt with in Part 4 of this section of the course, "Batteries in Service."

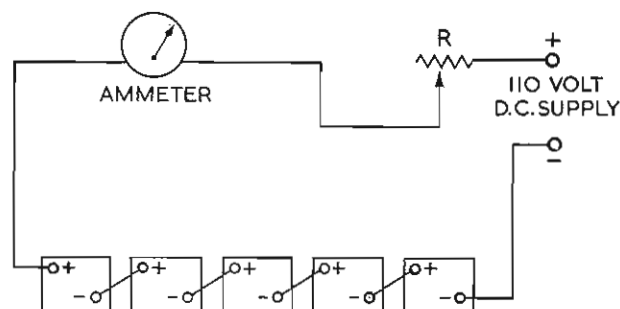

CONSTANT CURRENT SYSTEM

### DURATION AND RATE OF INITIAL CHARGE

Our label instructions giving the duration and rate of the initial charge **MUST** be followed if the best performance and the longest life are to be obtained from the battery.

In general the initial charging rate of approximately 1/15 of the nominal capacity at the 10 hour rating. Charge at this constant current for 80 hours, or until voltage readings and temperature — corrected S.G. readings show no increase over five successive hourly readings. Throughout the charge, the acid must be kept level with the top of the separators in each cell by the addition of acid solution of the same gravity as the original filling-in acid. If for any reason the charge has to be continued beyond the point where S.G. and voltage readings remain constant for five consecutive hours, distilled water should be used for topping up.

As far as possible, the initial charge should not be interrupted, but if the temperature of the electrolyte in any cell reaches 100°F., the charging should be stopped and the temperature allowed to fall at least 10°F. before charging is resumed.

### DURATION AND RATE OF CHARGE

Flat Plate Batteries:  
up to 80 hours.

Armoured Plate Batteries:  
100 hours actual.

Maximum allowable temperature when on charge.

Temperate climates 100°F.

Hot climates 110°F.

### ADJUSTMENT OF ACID STRENGTH.

At the end of the charge, i.e. when S.G. and Voltage measurements remain substantially constant, carefully check the S.G. in each cell to ensure that it lies within the limits specified by the manufacturers' instructions. If any cell requires adjustment, some

electrolyte must be syphoned off and replaced with a corresponding quantity of either acid of the strength used for the original filling or distilled water, according to whether the S.G. is too low or too high. After such adjustment, the gassing charge should be continued for one to two hours to ensure adequate mixing of the electrolyte.

## THE DRY-CHARGED BATTERY.

Obviously a great amount of time and trouble would be saved if this business of initial charging were not necessary. With this thought in mind, our battery technicians set about producing a battery which could be put directly into service without initial charging.

The result of their labours is the Lucas "DRY CHARGED" battery — recognisable by the RED instruction label.

In the absence of the label the Dry-Charged Batteries can always be distinguished by the letter "Z" appearing in the type symbol. For example the lettering GTZ7A will appear on one of the cell connectors — The "Former."

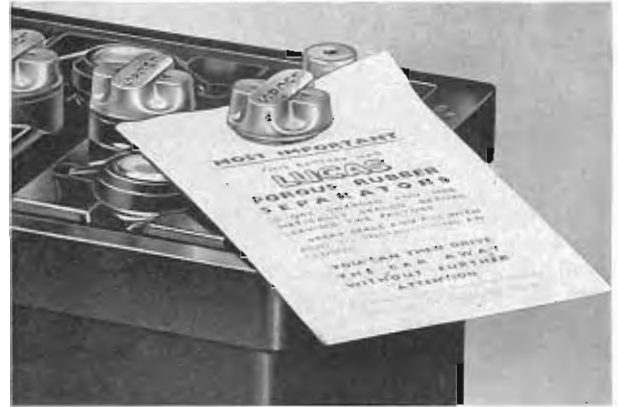

## NO INITIAL CHARGING.

You will remember that before dealing with initial charging, we explained why this was necessary. During the normal drying process after the formation charge, the negative plate loses its charge, the "spongy lead" active material combining with the oxygen of the air. A method of drying the plates in an oxygen-

free atmosphere has been perfected, the result being that both positive and negative plates remain charged. The sets of plates are then assembled, the separators inserted and the cells hermetically sealed. Thus we have a battery which can truly be termed "DRY CHARGED." This battery can be put into service immediately without initial charging.

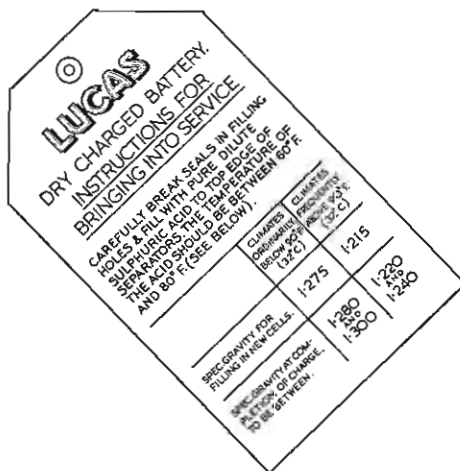

## PUTTING THE DRY CHARGED BATTERY INTO SERVICE.

After breaking the seals each cell should be filled with electrolyte of the correct S.G. The battery *MUST* be filled to the top of the separators in one operation. After this "one-stage" filling, the battery will be up to 90% charged, and may immediately be fitted to a vehicle. When time permits however, a short "freshening charge" will ensure that the battery is completely charged. Such a freshening charge should last no more than 4 hours at the normal recharge rate of the battery. During this charge, the electrolyte must be maintained at the level of the separators by the addition of distilled water.

Our instructions should again be referred to for electrolyte strengths and recharge rates. We emphasise here that the "dry-charged" battery can be treated in service in exactly the same manner as normal batteries.

## Batteries in Service

### BATTERIES IN SERVICE.

This section of the Battery Course deals mainly with practical points concerning the maintenance of batteries in service, remembering that without proper attention, even the best product is doomed to early failure.

### BATTERY STOWAGE.

Let us first make a check on the installation of the battery. By this we mean the battery stowage and all metal parts in the immediate proximity of the battery, including the lugs and the earth cable or braid.

The battery should be kept clean and dry and any traces of acid spillage removed by ammonia, or hot water if this is not available. Otherwise corrosion and extensive damage to the metal work will result.

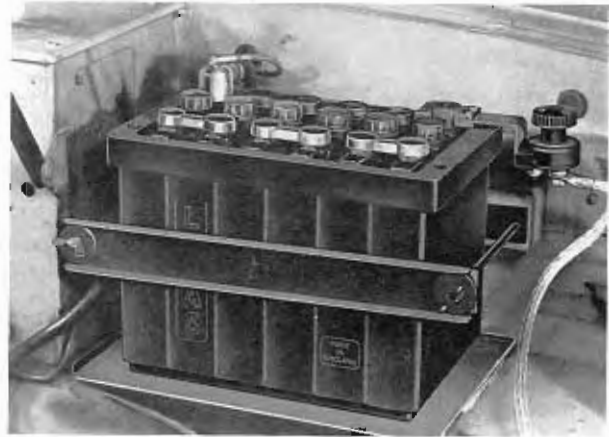

### BATTERY LUG (OLD CLAMP TYPE).

Battery lug corrosion is a more serious matter than is generally realised. Heavy corrosion on the battery lugs and posts results in considerable voltage drop when a heavy current is passing, for example, when the starter is operated voltage drop will usually be noticeable by sluggish operation of the starter motor.

The rate of corrosion is dependent on two factors : The thickness of the lead covering the cast brass of the lug and the amount of acid allowed to accumulate on the battery top.

This latter is your responsibility : we, on our part, as manufacturers, produce a special alloy which is far in advance of the normal lead-coated brass lug, and reduces corrosion to an absolute minimum. This alloy lug is now used mainly for commercial vehicles, with a new diecast lead lug superseding the old clamp type on normal cars.

### BATTERY LUG (DIE CAST).

Here we give an illustration of the die-cast battery lug fitted almost exclusively on present-day British cars. This lug further reduces corrosion.

The following points should be observed when refitting these lugs.

Clean off any oxidation from the battery post and smear the post and lug with *commercial vaseline*. Grease must *not* be used for this purpose.

When fitting the lug, make sure that the two surfaces marry together properly. Insert the "Parker-Kalon" locking screw *after* pressing home the lug on to the tapered battery post.

If these precautions are observed, no bad connections can develop and removal of the lug is always easy.



## REPLACEMENT KIT.

A standard Lucas replacement kit is available for repairing either a corroded brass lug, or a damaged length of battery cable. As you can see in this photograph, the new die-cast lug is used. This, coupled with a length of starter cable, a brass connector-sleeve, a self-tapping screw, and, in the case of the insulated cable, a piece of rubber sleeving, constitutes the kit.

In the top picture the old battery lug has been cut off ; half an inch of the existing cable outer-covering stripped back ; the rubber sleeve pulled over the new section of cable ; the bare end of the existing cable pushed into the brass connector-sleeve, and the joint soldered.

## INSULATING THE JOINT.

After allowing the joint to cool, it should be bound with a few turns of insulation tape and the rubber sleeving pulled over.

After smearing the battery post with commercial vaseline, the lug can be pushed firmly into position and the self-tapping screw inserted.

The replacement kit for the non-insulated battery lead, the positive earth cable on the modern car, consists of a braided earth cable with a die-cast lug, a brass connector and a self-tapping screw.

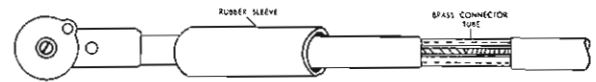

EXISTING CABLE AFTER STRIPPING SOLDERED INTO JOINTING TUBE

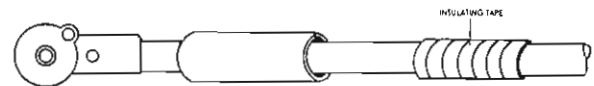

JOINT BOUND WITH INSULATING TAPE

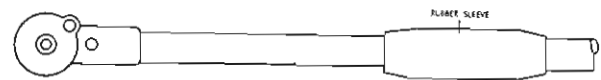

COMPLETED REPAIR RUBBER SLEEVE COVERING TAPE

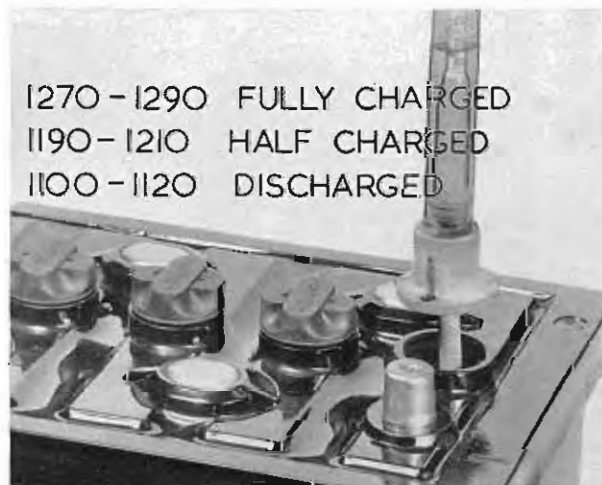

## HYDROMETER TESTING.

We shall now concentrate more on the inside of the battery, dealing first with acid and voltage testing, and then with the electrolyte level.

We have already explained the meaning of specific gravity in Part 1 of this section of the course and will now merely quote approximate gravity readings for our batteries :

Fully charged	...	1270—1290
Half	„	1190—1210
Discharge	...	1100—1120

---

## THE HEAVY DISCHARGE TEST.

The hydrometer test gives us a fairly accurate account of the state of charge of each cell, but a further test must be made to make sure that each cell will supply heavy currents at the required voltage, the heavy starting currents for instance. For this purpose, we use a "heavy discharge tester" which puts an electrical load on each cell. The load, or resistance, takes at least 150 amperes from the cell in the case of a car battery, thus reproducing conditions similar to those existing when the starter motor is operated. If the hydrometer test showed the cell to be charged, and if, under these test conditions, the cell voltage remains constant at approximately 1.5 to 1.6 volts, we can be sure the cell is serviceable. A rapidly falling voltage reading indicates a weak cell. The drop tests should be held in position for about 15 seconds for each cell in the battery.

We use the same type of tester for motor cycle



batteries, but a smaller load, this time of 12 amps. is adequate.

For a commercial vehicle batteries a drop tester with a load of 300 amps. must be used.

---

## Discharged Batteries

Batteries below half charge in service should be recharged by an external supply 80% full charge minimum.

## THE IMPORTANCE OF CHARGING FROM AN EXTERNAL SOURCE.

If the heavy discharge test proves the battery to be serviceable, but the gravity reading indicates that it is only half charged, i.e., between 1190—1210, the battery must be re-charged from an external source. It should not be put back into normal service until it is at least 80% charged. Care must be taken that this minimum figure is reached, particularly in winter-time when heavier currents are needed for starting.

---

## RECHARGING IN SERVICE.

Generally, recharging presents no problems if the charging rates quoted on our instruction labels are adhered to.

The normal charging rate is usually approximately 1/10 of the Amp./Hour capacity of the battery at the 10 hour rate. The charge must be continued until voltage and specific gravity readings show no increase over three successive hourly readings.

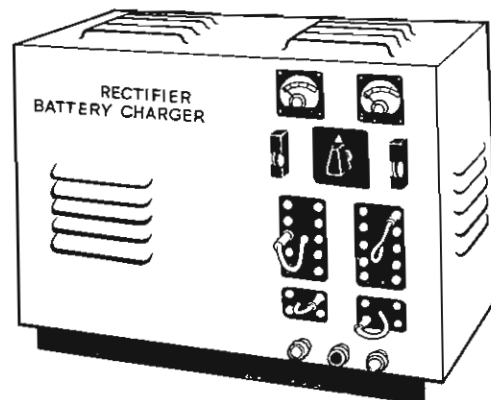

## CHARGING METHODS.

Either the constant current method, which we advocated for initial charging, or the constant voltage method may be employed for recharging. In either case a DIRECT CURRENT supply must be used. The connections to be made differ with the method and can be seen from the diagram. You will see that, using the constant current method, the batteries are in series. Thus a limit is set to the number of batteries that may be charged in series, since the voltage of the batteries when fully charged must not exceed the supply voltage. It is found in practice that the most suitable arrangement is ten 6 volt batteries or five 12 volt batteries when charging from a 110 volt supply.

With the constant voltage system, the batteries are connected in parallel, usually to a low voltage motor-generator set. The number of batteries that can be charged on one generator is here limited by the rated current output of the generator, and the total of the charging currents required for all the batteries must not exceed this output.

The supply voltage can again be regulated by a rheostat, and, if necessary, a rheostat or resistance can be included in the supply line to an individual battery, where a lower charging rate is required for this battery.

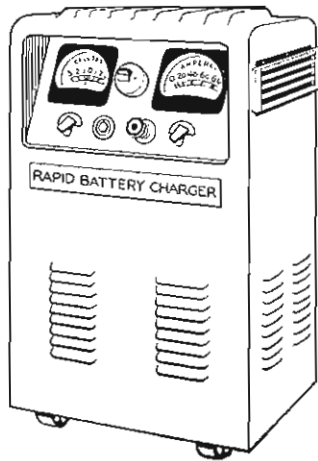
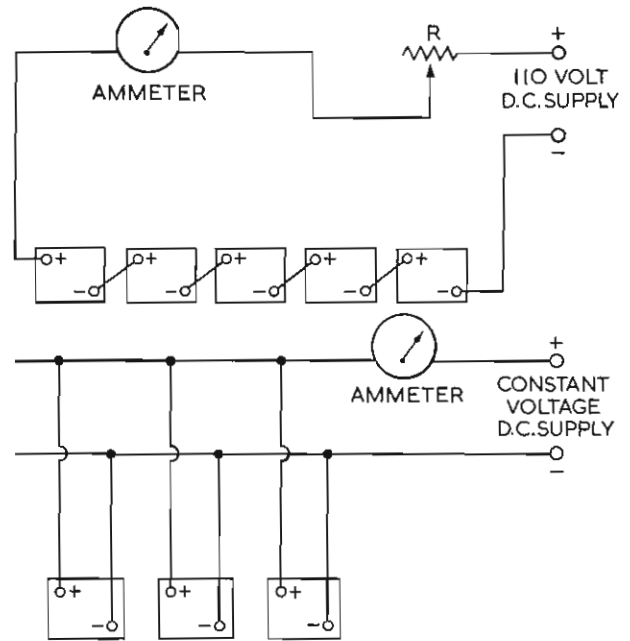

## BOOST CHARGING.

Rapid chargers or "boosters" should only be used for charging if there is any real urgency. They must always be supervised and should never normally be used to replace the standard charging method. No harm will be done through rapid charging if the battery is in a healthy discharged condition, although obviously rather more intelligent supervision will be needed than for ordinary charging.

A battery can be substantially recharged, i.e., to between 70%—80% of its fully-charged state, in anything between 30–60 minutes, dependent upon the state of discharge and the battery temperature.

And temperature is here the controlling factor. On no account should a temperature of 110°F. be exceeded, or the battery will be ruined.

Judge for yourselves : at 140°F. the paste starts leaving the grids.

## THERMOSTAT FOR TEMPERATURE CONTROL DURING BOOST CHARGING.

For the purpose of controlling temperature, a thermostat switch must be employed. This should be placed in the middle cell of 6 volt batteries, and either of the two centre cells of 12 volt batteries.

While we are discussing this subject of temperature, we will remind you once more of the necessity for temperature correction of gravity readings if variations from the mean temperature of 60°F. are encountered.

The importance of correct charging cannot be  
(continued)

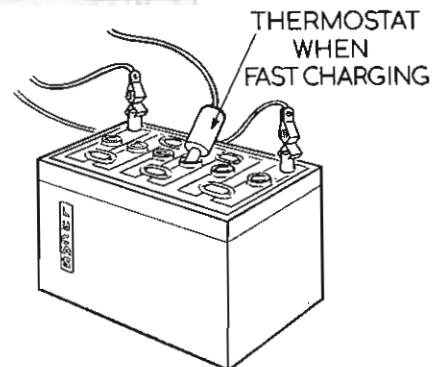

TEMPERATURE TO BE KEPT  
BELOW 110°F.

over-estimated as far as the life of the battery is concerned. If, at any time, particularly in winter, a battery should become completely discharged, it is very bad practice to leave it in the hope that it will become fully recharged by the vehicle dynamo.

Unless the battery is charged by an external source, it will probably never become more than half-charged, and, even though it appears to be working satisfactorily, the plates harden and the life of the battery will be considerably shortened.

### EFFECT OF TEMPERATURE ON DISCHARGED BATTERIES.

When left in a low state of charge, batteries can freeze easily. You can see from the figures given that a battery with a gravity of 1.100 will freeze at 18°F., that is 14° of frost, a condition by no means impossible even in the mild climate of the British Isles.

FREEZING POINT OF WATER  
(i.e. 1.000)= +32°F.

FREEZING POINT OF ELECTROLYTE AT  
1.100= +18°F.

FREEZING POINT OF ELECTROLYTE AT  
1.200= -17°F.

FREEZING POINT OF ELECTROLYTE AT  
1.300= -95°F.

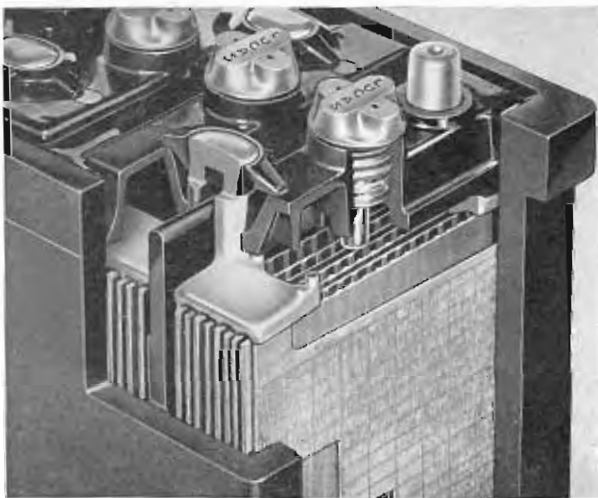

### THE ELECTROLYTE LEVEL.

We must deal with one further point as far as maintenance of batteries in service is concerned, that is, *topping up*.

We have already touched on this subject at various times in this section of the course and will now give a short summary. The electrolyte level should be maintained at the top of the separators by topping-up *with distilled water*. Underfilling will harm the battery plates; overfilling can only result in acid spillage, probably all over the engine compartment. Topping-up to the correct level leaves ample room for the charging gases to expand without flooding the Vent Plugs and causing external lug-corrosion and damage to surrounding metal work and upholstery.

During the normal service life of the battery it should NEVER be necessary to top up with acid electrolyte. Of course if an appreciable amount of acid has been spilled from the battery, it may be replaced by acid of the same S.G.

We also strongly disagree with the practice of changing the battery acid. It should never normally be necessary and, when the battery is turned upside down, sediment from the bottom of the container falls *between the plates, becomes wedged and inevitably causes short circuit*.



## BATTERY FILLER.

This business of "topping-up" is often neglected simply because in some cases it requires a contortionist to see into the top of the battery tucked away somewhere at the back of the engine compartment. Lucas have simplified the process by patenting this battery filler. The device ensures that filling automatically ceases at the separator level.



## RATE OF LOSS OF CHARGE

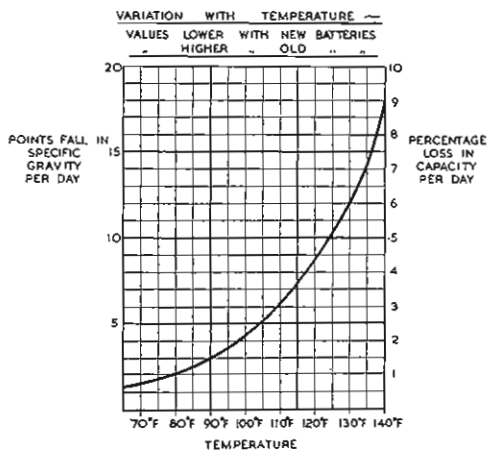

## CURRENT LOSSES.

Having set-out to discuss the maintenance of batteries in service, we must mention current losses which occur when the battery is standing.

Any charged battery that is left standing will discharge itself over a period of time. This self-discharge is inevitable, taking place even under the best conditions. The diagram shows exactly at what rate this takes place. You can see quite clearly how higher temperature increases the rate.

You will realise now why it is so important to keep the surface of the battery clean and dry and thus minimise self-discharge.

Current leakage can also occur internally between two adjacent cells, when for some reason the cell partition is defective or the sealing compound cracked.

## Batteries in Storage and Service

### STORAGE CONDITIONS — TEMPERATURE AND STACKING.

We shall now attempt to deal with a very large Subject very briefly, in that we shall give you a clear idea of the conditions necessary for battery storage, without going into details of actual storage rooms, etc.

We shall deal separately with dry batteries, (that is with batteries that have not been filled and charged) : with charged batteries and with the latest dry-charged batteries.

All batteries, whatever their breed, should be stored in as dry an atmosphere as possible, within temperature limits of 32° and 90°F. They should be kept out of the direct rays of the sun.

Dry batteries can be stacked, provided that they are placed the correct way up and not on their sides. Car types and X and CX commercial type batteries should be stacked not more than four high, wooden spacers being placed lengthwise between layers. If the batteries are cartoned, they may be stacked six high. CV and CF types, the heavier batteries, should not be stacked more than one battery high, either in storage or transit.

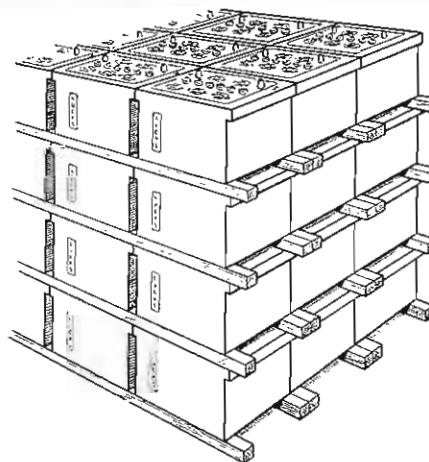

TEMPERATURE 32°F to 90°F.

If the above conditions are observed dry batteries need no further supervision and, providing the cell seals are not damaged, may be stored more or less indefinitely. However, generally speaking the sooner a new battery is charged the better ; prolonged storage usually necessitates longer first charging.

## STORAGE OF CHARGED BATTERIES

### STORING NEW "CHARGED" BATTERIES.

To retain new "charged" batteries in first class condition each battery should receive a "freshening charge" of four hours every month at the recommended recharge rate. Care should be taken to see that the cells are topped-up with distilled water to the level of the separators. And we repeat that the surface of the batteries must be kept clean and dry. This precaution minimises self-discharge, the reason for the "freshening-charge," of course. You remember from the graph shown on page 26 how the self-discharge increased with temperature. This is the reason why the temperature of the storage room must be controlled. Too high a temperature will mean that the freshening charge must be given more frequently than once a month.

### STORING "KING OF THE ROAD" AND DRY CHARGED BATTERIES.

Our latest batteries, both the normal dry uncharged and the 'dry charged' types lend themselves ideally to storage, due to their being fitted with porous rubber separators.

In fact, in the case of the dry uncharged battery, our engineers have proved that with these new separators, the usual hermetic sealing ('flash seal') is no longer necessary.

It will be appreciated however from what we have said earlier concerning the method of production of the 'dry-charged' battery, that the sealing must still be retained. The vent plugs are provided with small plastic stoppers and then taped over.

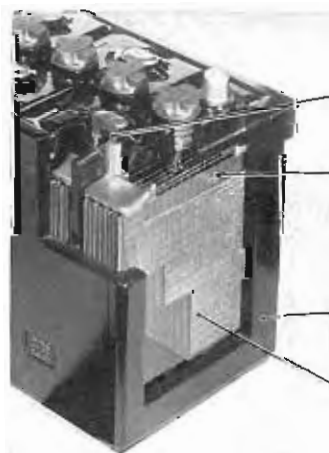

Lucas Patent semi-linkless cell assemblies give the most advanced clean top to battery, the shortened inter-cell connectors reducing the internal resistance.

Lucas Patent Porous Rubber Separators — for high efficiency — ensure long life and maximum performance.

Lucas "Milam" Cases, tested to 60,000 volts, are fitted with reinforced inter-cell partitions.

Lucas grid alloy — only the finest refined lead is used — its high resistance to corrosion ensures long battery life and high performance.

---

The illustrations which follow will show you just what is likely to happen to the inside and outside of a battery if it is not properly looked after.

If these batteries had been properly maintained, that is : kept clean and dry, topped-up, and correctly charged, these faults would not have occurred.

### **CORRODED BATTERY LUGS.**

The result of neglect. Keeping the battery top dry, and the lugs clean and coated with vaseline would have avoided this. Even our new die-cast lug, although limiting corrosion to an absolute minimum, must still be efficiently maintained.

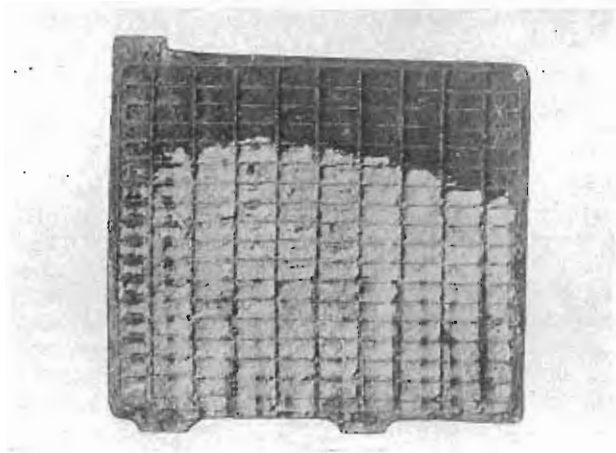
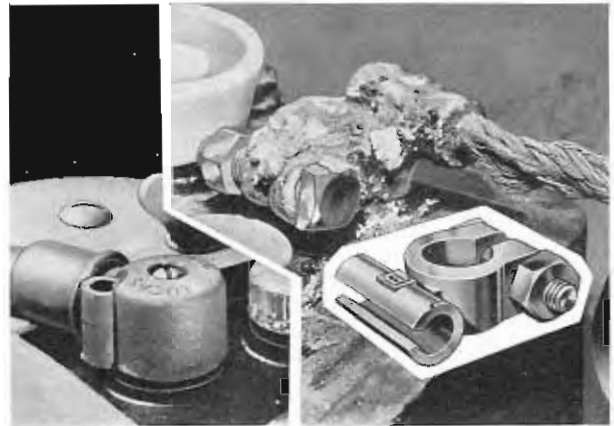

### **ACID LEVEL NEGLECT.**

This cell had not been topped up. You can see that the acid level was only halfway up the plates instead of at the top of the separators. The plates are divided into upper and lower areas of different colour and texture. It is clear too that the battery had been standing idle in a badly discharged condition. In this photograph of the positive plate, the white of the inert Lead Sulphate is very obvious against the chocolate-coloured active lead peroxide at the top.

### **OVER DISCHARGED NEGATIVE PLATE.**

Here we have over-discharging as it affects the negative. The paste on this negative plate is hard and light in colour — Lead Sulphate again.

This can be the result of either over-discharging, persistent undercharging, or long standing without charging.



---

### OVERCHARGED NEGATIVE AND POSITIVE PLATES.

The result of over-charging. These negative and positive plates were taken from the same cell. The negative material was spongy and soft and you can see how, in the right hand illustration, the positive material is leaving the grid.

This lifting of the active material pellets on the positive plate could equally well have been caused by freezing when the battery was in a low state of charge.



OVERCHARGED NEGATIVE & POSITIVE PLATES

---

### OVERCHARGED NEGATIVE PLATE.



This negative plate shows even more clearly the result of overcharging. You can see that the active material surface is covered with small blisters.

### MUCH OVERCHARGED NEGATIVE PLATE.



Carrying this overcharging of the battery a little further, the negative plate would have this appearance. The grid, as you can see is weak and broken, and the paste conspicuous in many places by its absence.

---

### BUCKLING DUE TO OVERCHARGING.

Heavy overcharging can also cause buckling of the plates. These negative and positive plates come from the same cell. The over-charging had forced the active material from the Positive plate, on the right of the illustration, and the sediment caused an internal short circuit which led to increased buckling of the positive plate and disintegration of the negative.

We hope this buckling is evident from the photograph. If you look closely at the two inside edges of the plates you will notice that the positive is bent away from the straight edge of the negative.



---

### BUCKLING DUE TO OVER-DISCHARGING.

Buckling of battery plates can also be caused by a heavy over-discharge. The negative plate on the left is hard, and as you would expect, badly sulphated. The positive grid has been broken up by the buckling or expansion.

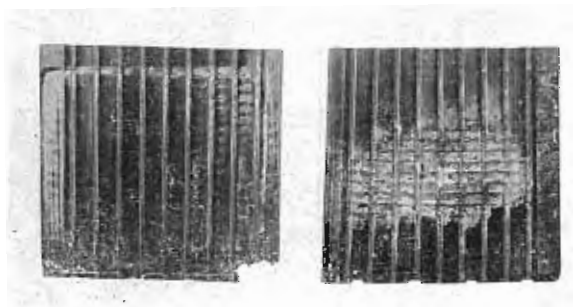
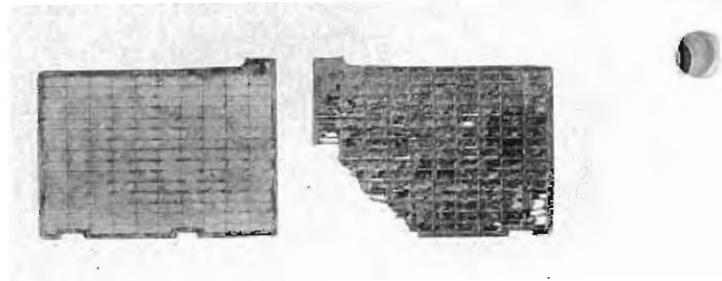

---

### BUCKLING THE EFFECT ON SEPARATORS.

These wood separators were taken from a cell having buckled plates due to over-discharge. Note the impression of the plates, made when they were expanded and particularly the wear at the bottom and centre.

---

### HEALTHY PLATES.

When in a healthy condition and normally charged, the negative plate should be slate grey in colour with a soft surface — soft enough to mark easily with the finger nail, but in no way “soggy” or blistered.

The positive plate should be chocolate brown with a relatively hard surface.

In both cases the grids should show no signs of wear, nor should the paste pellets be lifting.

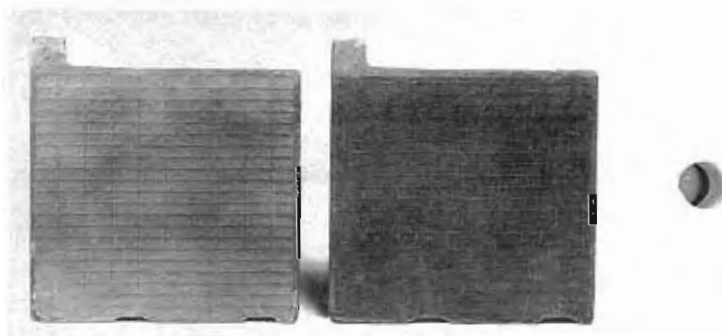

---

### POSTSCRIPT.

Perhaps, after studying all this information on the various phases of battery construction, repair and service, the student may have gained the impression that this is a highly complex subject. It certainly is, when considered from the manufacturing point of view, but we have given you an insight into some of the deeper technical problems merely in the hope that you will appreciate how important it is that a battery is correctly selected for its work and intelligently serviced throughout its life.

One essential fact stands out in connection with a battery that does not apply to any other electrical component, and that is — that being an electro-chemical unit — it commences its effective life from the day of its assembly, and whether it is put into active use on a vehicle or kept on a shelf in the stores, its life has started and regular maintenance in one form or another is of the utmost importance.

If the advice and instructions given in this book are understood and closely followed, we are confident that your efforts will be amply repaid in the form of satisfied customers.